

CORRU SLIDE®

WATERTIGHT, ADJUSTABLE HINGED MOUNT

CorruSlide is engineered for a universal fit on nearly all corrugated metal roof profiles. The adjustable hinge-style mount attaches to the sides of the panel ribs, away from the valleys where water flows, and moisture accumulates. CorruSlide features North-South & East-West adjustability, and the pre-installed EPDM gasket tape and five self-tapping screws with EPDM washers ensure rugged watertight performance.

FEATURES & BENEFITS

- Patented watertight technology
- Versatile hinge design fits any profile
- Pre-installed EPDM gasket tape forms an impenetrable moisture barrier
- Five self-tapping screws with EPDM washers ensure optimum strength
- Ideal for use on both commercial and residential applications

MULTIPLE WATERTIGHT FASTENERS FOR OPTIMUM STRENGTH



Corrugated



Rail-Based
Rail-Less







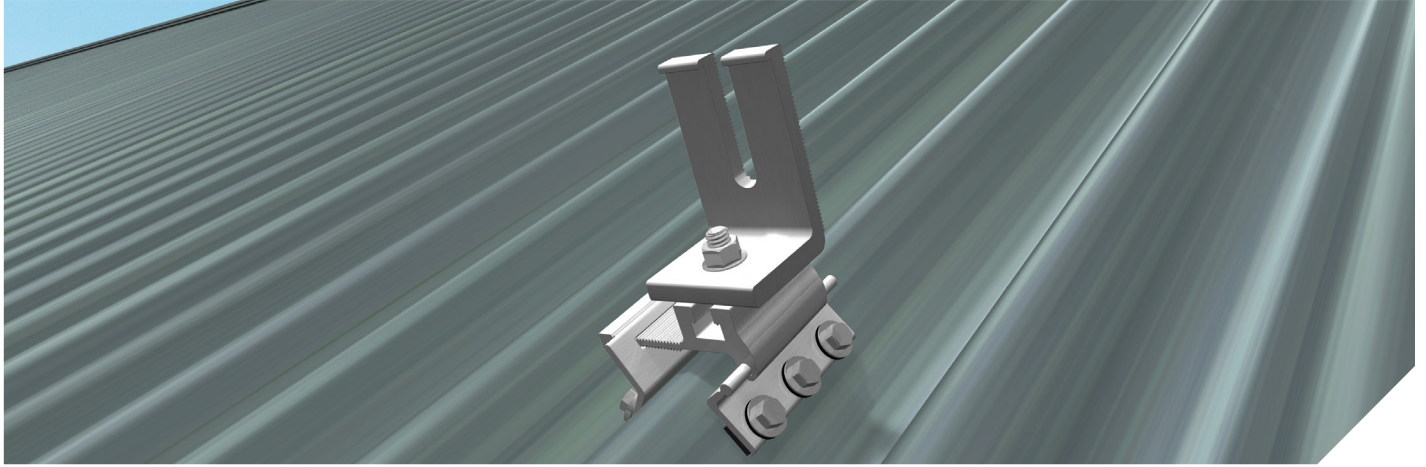

Direct-Attach
to Corrugation



CORRUSLIDE. WATERTIGHT, ADJUSTABLE HINGED MOUNT



	PRODUCT IMAGE	PART NUMBER	PART DESCRIPTION	BOX QUANTITY	PALLET QUANTITY
MOUNT	ASSEMBLED WITH EPDM GASKET, INCLUDES (5) SELF TAPPING SCREWS WITH EPDM WASHERS, (1) SS HEX BOLT & (1) SS FLANGE NUT				
		3014010	CORRUSLIDE MOUNT AL	50	2250
BRACKETS	INCLUDES (1) 3/8"-16 X 1 1/4" HEX BOLT AND (1) 3/8"-16 FLANGE NUT FOR RACKING				
		2012022	CF L-FOOT MLL 3" (NO HARDWARE NEEDED)	50	1800
		3011018	L-FOOT SCL-101 BLK 3"	50	6000
		3011015	L-FOOT L-102 BLK 3"	50	6000
		3011017	L-FOOT SCL-101 MLL 3"	50	6000
		3011016*	L-FOOT L-102 MLL 6"	50	2400

CORRUSLIDE

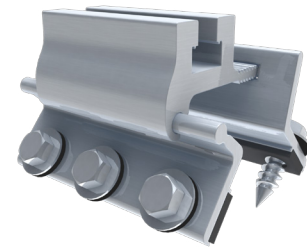

3014010

CHOOSE YOUR BRACKET:

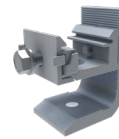

2012022



3011015



3011016*

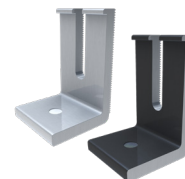

3011017
3011018

CORRUSLIDE IS ALSO COMPATIBLE WITH THIRD-PARTY BRACKETS

* SPECIAL ORDER ITEM

CorruSlide's hinged tongue-and-groove design allows a custom-fit to most corrugated profiles

