

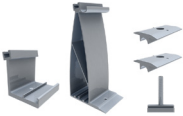



	PRODUCT IMAGE	PART NUMBER	PART DESCRIPTION	BOX QUANTITY	PALLET QUANTITY
SYSTEM	INCLUDES (1) SHORT LEG, (1) TALL LEG, (2) MIDCLAMPS, (2) FLANGE NUTS, (2) SET SCREWS & (2) T-NUT MOUNTS				
		2016010	SIMPLERACK TILT LEG KIT AL	12	360
		2099024	SB/SR END SPACER AL MLL 32MM	50/250	31250
		2099025	SB/SR END SPACER AL MLL 35MM	50/250	27000
2099026		SB/SR END SPACER AL MLL 40MM	50/300	28800	
ACCS.	ASSEMBLED WITH (1) CARRIAGE BOLT & (1) FLANGE NUT				
		4011012	FRAME MLPE MOUNT SS	50/300	12600

* SPECIAL ORDER ITEM



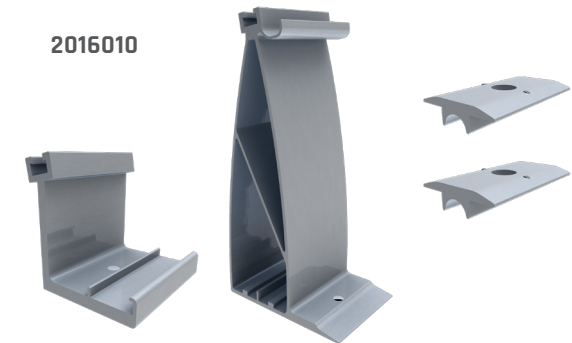

Features a
10° fixed tilt

SR-X LEG KIT:

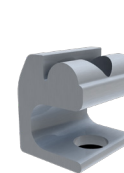

CHOOSE YOUR SPACER:



2099024

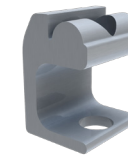

2099025



2099026